

FLAT TOP CHAINS

Conveying with confidence





FLAT TOP CHAINS

TIDC India manufactures and supplies Carbon Steel and Stainless Steel Flat Top Chains. Chains are produced in straight running and side flexing versions and the range is covered by a broad selection of raw materials and chain link profiles to provide solutions for all conveying applications. These Flat Top Chains are characterized by high working loads, highly-resistant to wear and extremely flat and smooth conveying surfaces. The chains can be used in many applications and are not just confined to the Beverage Industry.

Special Features



High performance stainless steel for high speed



Very high working load



High corrosion and wear resistance



Very high surface hardness through cold work hardening



Highest surface quality



Applicable for magnet chains



Working temperatures from -40°C till +260°C (-40°F till +500°F)



27 HRC in hardness measurement

Typical Applications

Beverage	Bottle filling lines for brewery, soft drink, juice and wine
Canning	Filling of cans (pet food, fruit and other food products)
Packaging	Packaging of glass, PET, cans and other packaging media
Dairy	Bottle filling and handling of products in tubs, jars and crate handling
Food	Handling of different packaged food products
Pharmaceutical	For bottle, tube and jar filling lines
Chemical	Filing of cans, drums and other packs
Printing	Handling of bound printed matter



STEEL STRAIGHT RUNNING CHAINS



SEIMITSU
ACCESS TO A BRIGHTER FUTURE

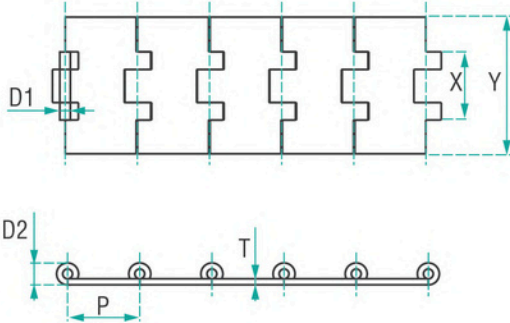

Single Hinge

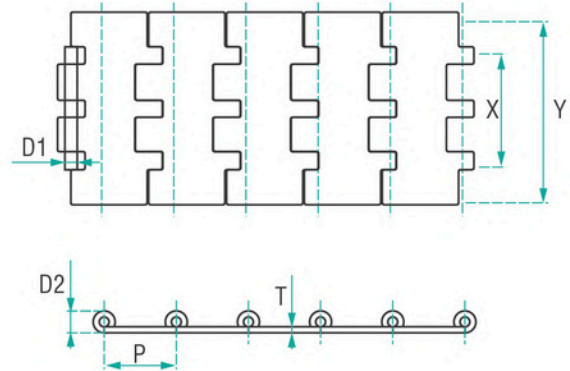

Double Hinge

STANDARD SERIES - STEEL STRAIGHT RUNNING CHAINS

Hinge Type	TIDC Drawing Number	Pitch P	Slat Width Y	Width Over Fixed Curls X	Pin Dia D1	Slat Thickness T	Curl Outside Dia D2 (Max)	Breaking Load Lbf		Weight in Kg/Meter
								304	420	
Single Hinge	FT 15 07620 STS	38.1	76.2	42.0	6.35/6	3.1/3	13.13	1800	1400	2.39
	FT 15 08260 STS		82.6							2.55
	FT 15 08890 STS		88.9							2.70
	FT 15 10160 STS		101.6							2.99
	FT 15 11430 STS		114.3							3.29
	FT 15 12700 STS		127.0							3.59
	FT 15 15240 STS		152.4							4.17
	FT 15 19050 STS		190.5							5.06
Double Hinge	FT 15 19050 STD	38.1	190.5	80.5	6.35/6	3.1/3	13.13	3600	2800	5.87
	FT 15 25400 STD		254.0							7.37
	FT 15 30480 STD		304.8							8.57

DERIVED SERIES - STEEL STRAIGHT RUNNING CHAINS

Hinge Type	TIDC Drawing Number	Pitch P	Slat Width Y	Width Over Fixed Curls X	Pin Dia D1	Slat Thickness T	Curl Outside Dia D2 (Max)	Breaking Load Lbf		Weight in Kg/Meter
								304	420	
Single Hinge	FT 10 05450 STS	25.4	54.5	42.0	6.35	3.1	13.13	1800	1400	2.26
	FT 10 06300 STS		63.0	40.5						2.55
	FT 10 07150 STS		71.5	42.0						2.79
	FT 10 07500 STS		75.0							2.87
	FT 10 08200 STS		82.0							2.94
	FT 10 08800 STS		88.0							3.08
	FT 10 09800 STS	98.0	3.30							
	FT 14 08000 STS	36.0	80.0	42.0						2.58
	FT 14 09000 STS		90.0							2.79
	FT 15 05300 STS	38.1	53.0							2.04
	FT 15 06500 STS		65.0							2.32

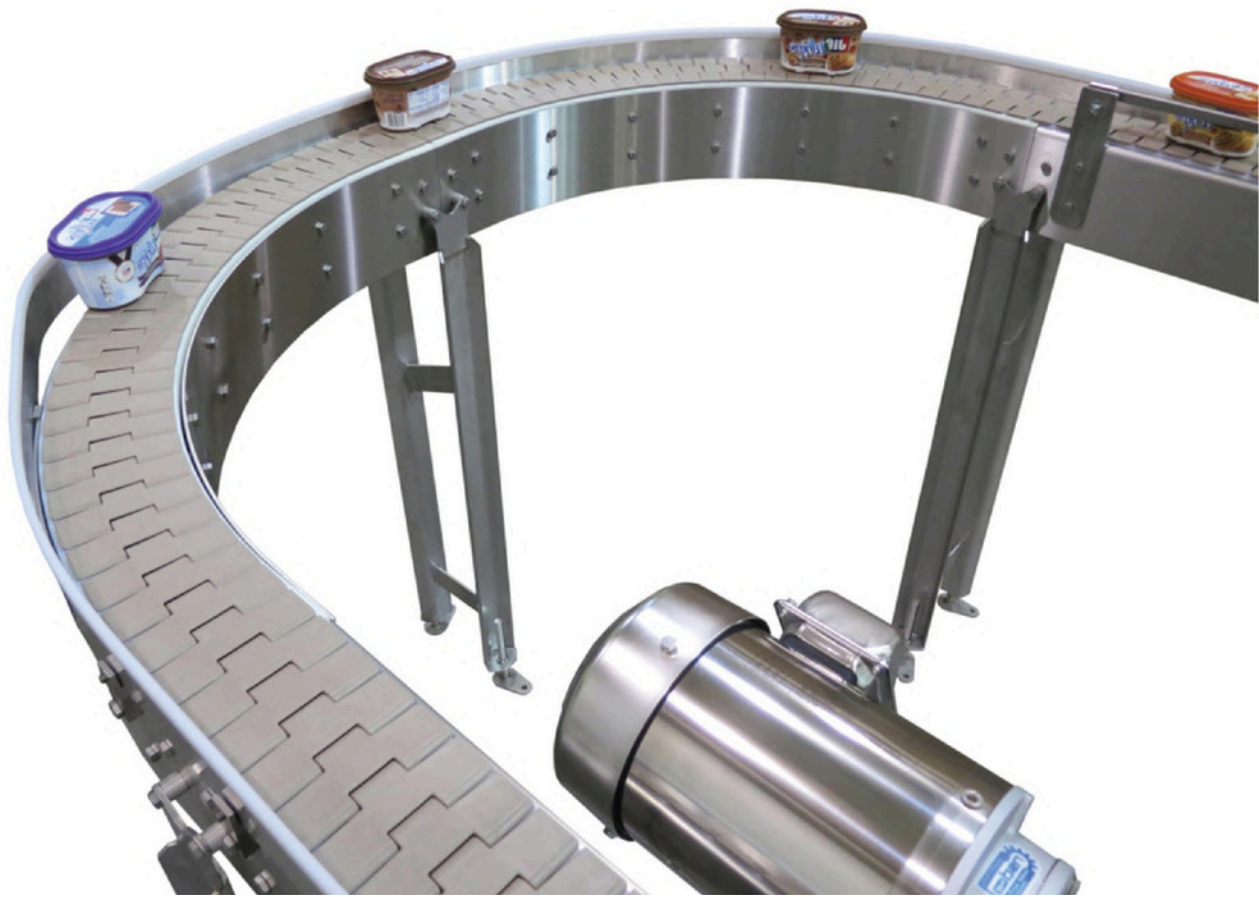

STEEL SIDEFLEX FLAT TOP CHAINS

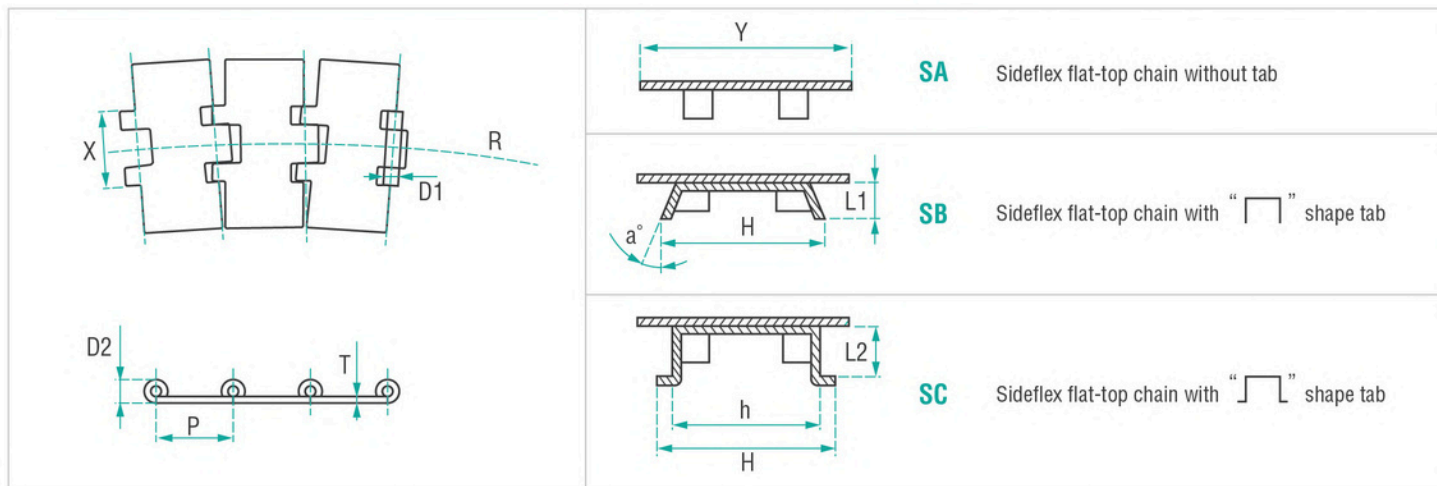

STEEL SIDEFLEX FLAT TOP CHAINS

TIDC Drawing Number	Pitch P	Slat Width Y	Width Over Fixed Curls X	Pin Dia D1	Slat Thickness T	Curl Outside Dia D2 (Max)	Side Flex Radius R (Min)	FLOAT - Prevention tab details					Breaking Load Lbf		Weight in Kg/Meter
								H	h	L1	L2	a°	304	420	
FT 15 08260 SA SF	38.1	82.6	42.0	6.35/6	3.1/3	13.8	460						1600	1260	2.52
FT 15 08260 SB SF			38.5					43	11	6.5	2.85				
FT 15 08260 SC SF			38.5					56	43	13.2	3.08				
FT 15 08890 SA SF	88.9	88.9	42.0	6.35/6	3.1/3	13.8	460					1600	1260	2.67	
FT 15 08890 SB SF			38.5					43	11	6.5	3.00				
FT 15 08890 SC SF			38.5					56	43	13.2	3.23				
FT 15 25400 SA SF	101.6	101.6	42.0	6.35/6	3.1/3	13.8	460					1600	1260	2.93	
FT 15 25400 SB SF			38.5					43	11	6.5	3.26				
FT 15 25400 SC SF			38.5					56	43	13.2	3.49				
FT 15 11430 SA SF	38.1	114.3	42.0	6.35/6	3.1/3	13.8	460					1600	1260	3.15	
FT 15 11430 SB SF			38.5					43	11	6.5	3.78				
FT 15 11430 SC SF			38.5					56	43	13.2	3.60				
FT 15 15240 SA SF	152.4	152.4	42.0	6.35/6	3.1/3	13.8	460					1600	1260	3.96	
FT 15 15240 SB SF			38.5					43	11	6.5	4.31				
FT 15 15240 SC SF			38.5					56	43	13.2	4.54				
FT 15 19050 SA SF	190.5	190.5	42.0	6.35/6	3.1/3	13.8	600					1600	1260	4.70	
FT 15 19050 SB SF			38.5					43	11	6.5	5.06				
FT 15 19050 SC SF			38.5					56	43	13.2	5.29				
FT 15 25400 SC SF	254.0	254.0	38.5	6.35/6	3.1/3	13.8	600	56	43	13.2				6.79	
FT 15 30480 SC SF	304.8	304.8	38.5	6.35/6	3.1/3	13.8	600	56	43	13.2				7.99	



Advantages

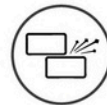

Superior wear life



Superior surface finish
for smooth operation



Uniform movement of goods

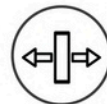

Less Elongation



Longer life

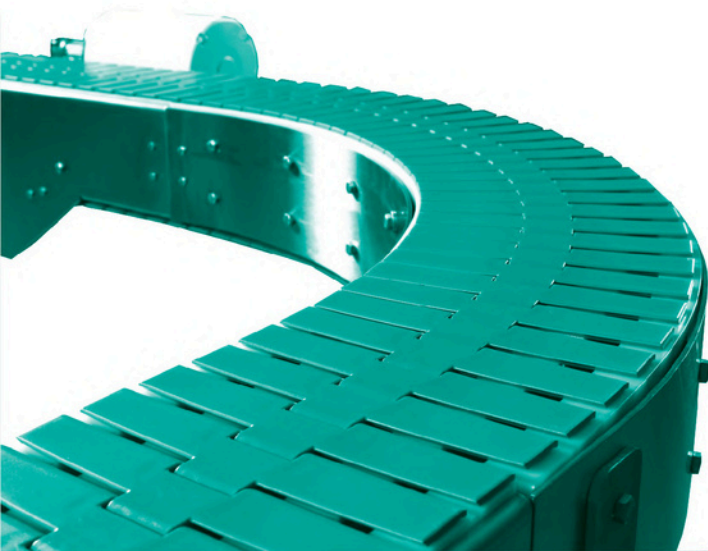

Seimitsu Tower, A - 51, H Block, MIDC Industrial Area,
Pimpri - Chinchwad, Pune - 411018, Maharashtra.



+91 9028121211 / 020 - 46212700



www.seimitsu.in



sales@seimitsu.in